

DVD Video Player
Owner's Manual



Let's make things better.



PHILIPS

General Information

Since it is usual for DVD movies to be released at different times in different regions of the world, all players have region codes and discs can have an optional region code. If you load a disc of a different region code to your player, you will see the region code notice on the screen. The disc will not playback, and should be unloaded.



Manufactured under license from Dolby Laboratories. "Dolby", "Pro Logic" and the double-D symbol are trademarks of Dolby Laboratories.

"DTS" and "DTS Digital Surround" are trademarks of Digital Theater Systems, Inc.

CAUTION
(WARNING LOCATION: ON THE BACKPLATE OF SET)
NEVER MAKE OR CHANGE CONNECTIONS WITH THE POWER SWITCHED ON.

For Customer Use:

Read carefully the information located at the rear panel of your DVD VIDEO player and enter below the Serial No. Retain this information for future reference.

Model No. DVD VIDEO
Serial No. _____

Laser safety

This unit employs a laser. Due to possible eye injury, only a qualified service person should remove the cover or attempt to service this device.

USE OF CONTROLS OR ADJUSTMENTS OR PERFORMANCE OF PROCEDURES OTHER THAN THOSE SPECIFIED HEREIN MAY RESULT IN HAZARDOUS RADIATION EXPOSURE.

LASER

| | |
|-----------------|---------------------------------|
| Type | Semiconductor laser GaAlAs |
| Wave length | 650 nm (DVD) 780 nm (VCD/CD) |
| Output Power | 7 mW (DVD) 10 mW (VCD/CD) |
| Beam divergence | 60 degree |

CAUTION
VISIBLE AND INVISIBLE LASER RADIATION
WHEN OPEN AVOID EXPOSURE TO BEAM

Important Note:
Due to the numerous versions of new CD-Audio copy protection or enhanced CD-Audio protection recently available on certain discs, Philips is unable to guarantee that this DVD player is fully compatible with such new discs. Should you have difficulty playing any such CD-Audio discs, kindly refer them to your CD-Audio disc retailer.



Contents

Introduction

| | |
|------------------------------------|---|
| Environmental Information | 4 |
| Supplied accessories | 4 |
| Safety Information | 4 |
| Symbols Used in this booklet | 4 |

Functional overview

| | |
|----------------------|---|
| Front panel | 5 |
| Rear panel | 5 |
| Remote control | 6 |

Preparation

| | |
|--|----|
| Basic Connection | 7 |
| Connecting to a TV | 7 |
| Connecting to Optional Equipment | 8 |
| Connecting to a Audio System | 8 |
| Inserting batteries into the Remote Control .. | 9 |
| Using the Remote control | 9 |
| NTSC/PAL Conversion | 9 |
| Switching On | 10 |

Operation

| | |
|--|----|
| Basic Playback | 10 |
| General Operation | 10 |
| Video control during playback | 10 |
| Audio control during playback | 11 |
| Repeat | 11 |
| Repeat A-B | 11 |
| 5 disc Resume | 11 |
| OSD (On-Screen Display) | 12 |
| Title Selection | 12 |
| Chapter Selection | 12 |
| Time Search | 12 |
| Zoom | 12 |
| Special DVD Features | 12 |
| Playing a title | 12 |
| Playing a chapter | 12 |
| Camera Angle | 12 |
| Changing the audio language | 12 |
| Subtitles | 12 |
| Special VCD & SVCD Features | 13 |
| Playback Control (PBC) | 13 |
| Preview function | 13 |

Picture CD & MP3 CD Playback

| | |
|----------------------------------|----|
| Function introduction..... | 14 |
| Basic playback | 14 |
| Auto playback | 14 |
| Selection playback | 14 |
| Preview playback | 14 |
| Playback with multi-angles | 14 |
| Playback Speed Control | 14 |
| Zoom picture | 14 |

KARAOKE

| | |
|---|----|
| General operation | 15 |
| General setup | 15 |
| Karaoke learning and language learning function | 15 |

Setup menu

| | |
|---------------------------------|----|
| Basic operation | 16 |
| General setup menu | 16 |
| Disc lock | 16 |
| VFD DIM..... | 16 |
| Program | 16 |
| OSD language | 17 |
| Screen saver | 17 |
| Speaker setup page | 17 |
| DOWNMIX mode | 17 |
| D.R.C | 17 |
| Center speaker | 18 |
| Surround speaker | 18 |
| Subwoofer speaker | 18 |
| Center delay | 18 |
| Surround delay | 18 |
| Bass Redirection | 18 |
| Test tone | 19 |
| Pro Logic setup | 19 |
| SPDIF setup | 19 |
| SPDIF OUT setup | 19 |
| LPCM 96K mode | 19 |
| Video Output setup | 20 |
| Video output | 20 |
| TV display | 20 |
| TV type | 20 |
| Smart Picture | 21 |
| Video Mode | 21 |
| Personal Picture Setting | 21 |
| Preferences setup | 22 |
| Audio language | 22 |
| Subtitle language | 22 |
| Disc menu language | 22 |
| Password | 22 |
| Parental control | 23 |
| Default setup..... | 23 |
| Smart Navigator | 23 |

Specifications

| | |
|----------------------|----|
| Specifications | 23 |
|----------------------|----|

Maintenance

| | |
|-------------------|----|
| Maintenance | 23 |
|-------------------|----|

Troubleshooting

| | |
|-----------------------|----|
| Troubleshooting | 24 |
|-----------------------|----|



Introduction

Thank you for purchasing this Philips DVD player. This Owner's Manual explains the basic operation of this DVD player.

Environmental Information

All unnecessary packaging has been omitted. We have tried to make the packaging easy to separate into three materials: cardboard (box), polystyrene foam (buffer) and polyethylene (bags, protective foam sheet).

Your DVD player consists of materials which can be recycled and reused if disassembled by a specialized company. Please observe the local regulations regarding the disposal of packaging materials, exhausted batteries and old equipment.

Supplied accessories

- DVD-Video player
- Remote control with Batteries
- Audio cable
- Video cable
- Owner's Manual

Safety Information





- Before operating the DVD player, check that the operating voltage indicated on the typeplate is identical with the voltage of your local power supply. If not, please consult your dealer.
- Place the DVD player on a flat, hard and stable surface.
- There must be sufficient room in front of the player for the drawer to be opened.
- In cabinet, allow about 2.5cm (1 inch) of free space all around the player for adequate ventilation.
- Do not expose your player to extreme of temperature or humidity.
- If the DVD player is brought directly from a cold to a warm location, or is placed in a very damp

room, moisture may condense on the lens of the disc unit inside the DVD player. Should this occur, the DVD player would not operate normally. Leave the power on for about one hour with no disc in the DVD player until normal playback is possible.

- The mechanical parts of the set contain self-lubricating bearings and must not be oiled or lubricated.
- When the DVD player is switched to Standby mode, it is still consuming some power. To disconnect the system from the power supply completely, remove the AC power plug from the wall socket.

Symbols Used in this Booklet

The below symbols appear in some headings and notes with the following meanings:

| | |
|---|---|
|  | - Description refers to playback of DVD-video discs |
|  | - Description refers to playback of Video CDs |
|  | - Description refers to playback of Audio CDs |
|  | - Description refers to playback of Super VCDs |

Helpful Hints!

- **Some DVD video discs require specific or allow only limited functions during playback.**



Functional Overview

Front and Rear Panels

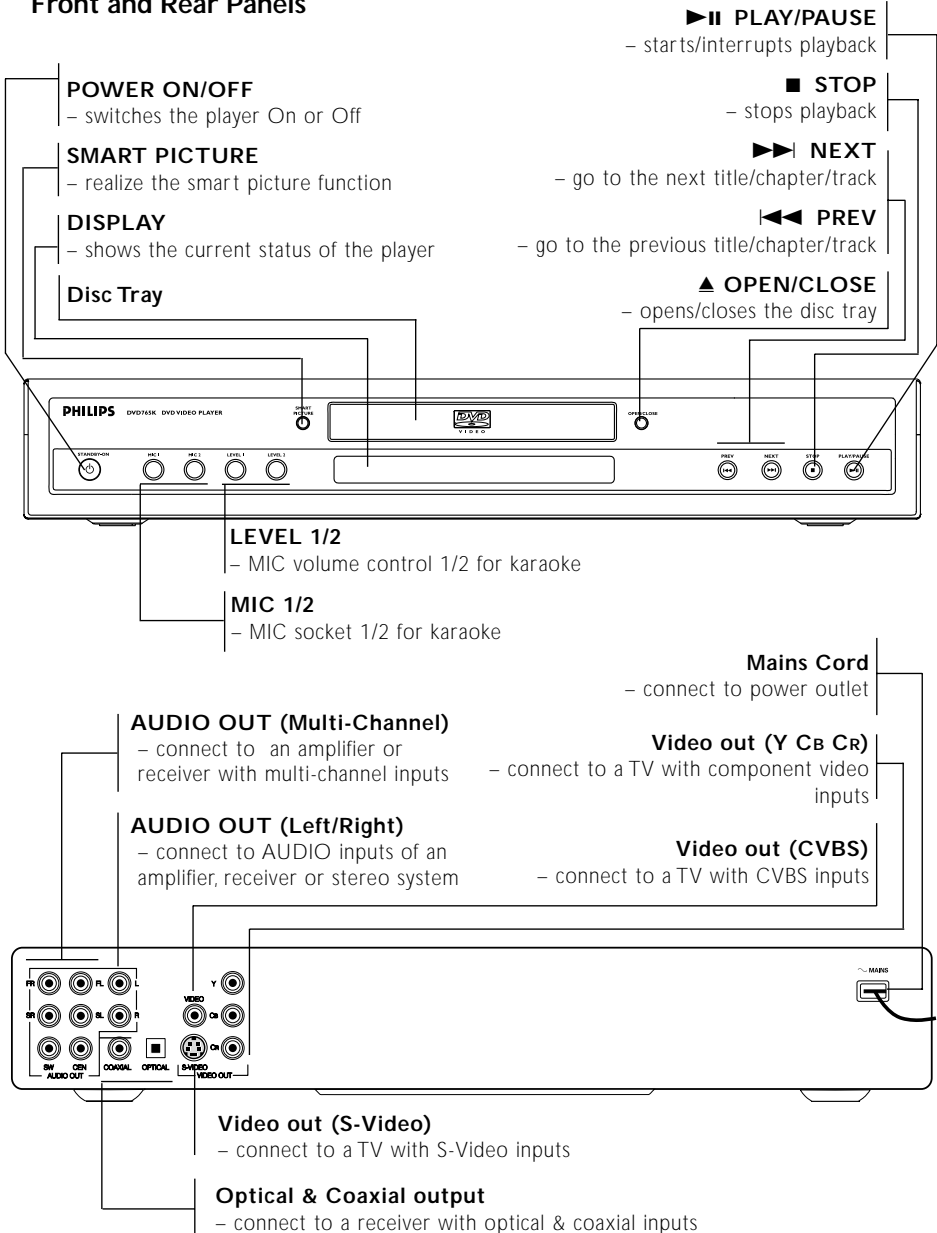

Caution: Do not touch the inner pins of the jacks on the rear panel. Electrostatic discharge may cause permanent damage to the unit.

Functional Overview

Remote Control

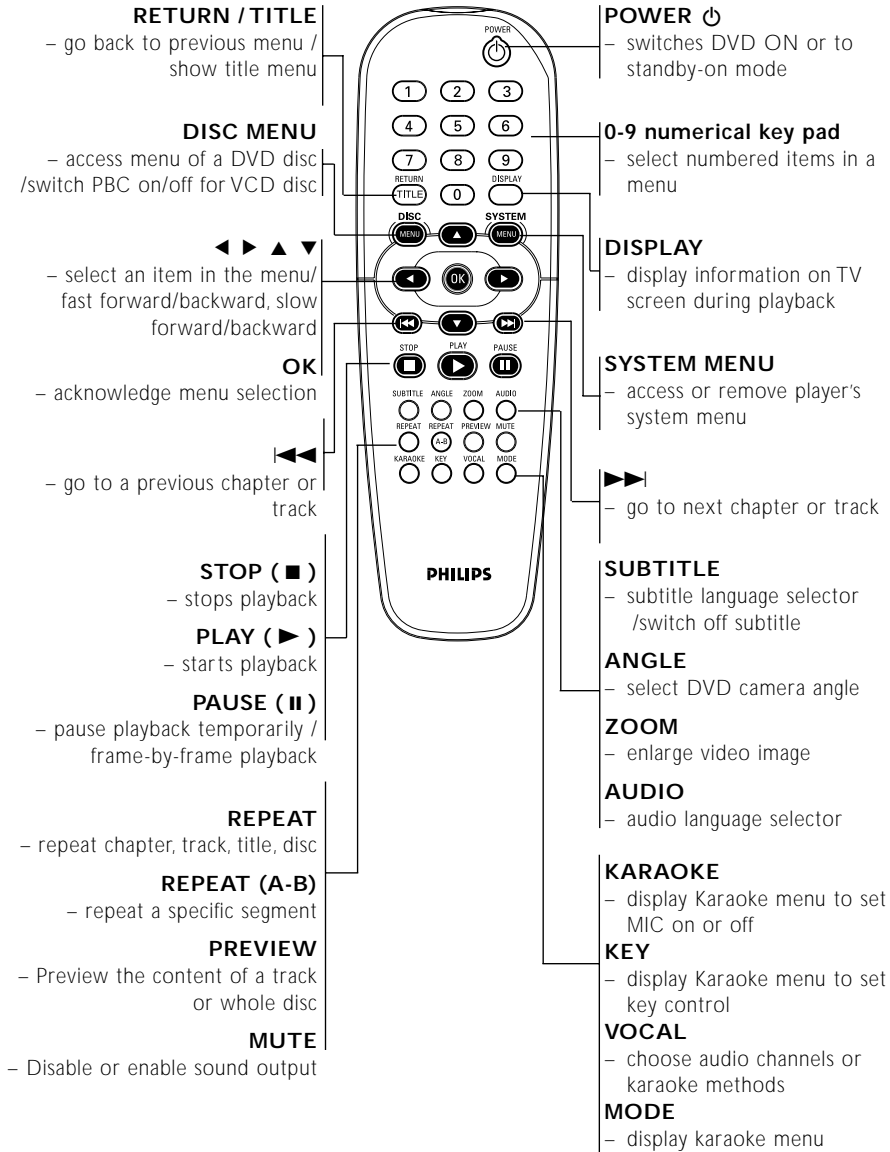

Note:
Press digit "1" for about 2 seconds to OPEN or CLOSE disc tray.



Preparation

Basic Connections

- Please refer to the instruction books of your TV, VCR, Stereo System or other devices as necessary to make the best connections.

- Make one of the following connections, depending on the capabilities of your existing equipment.

The following guidelines are options for the best picture and sound quality available on your DVD player.

Video Connections

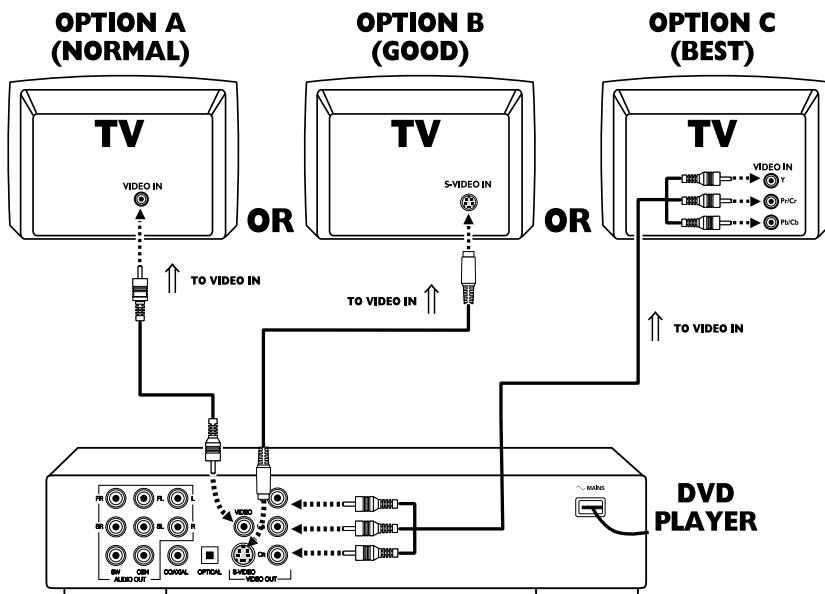

Connecting to a TV

If your TV has a CVBS Video input connector,

- Connect the CVBS VIDEO OUT on the DVD player to the CVBS VIDEO IN (cable supplied).

If your TV has a S-Video input connector,

- Connect the S-Video OUT on the DVD player to the S-Video IN (not supplied).

If your TV has a Component video (Y/Cb/Cr) input connector,

- Connect the Y/Cb/CR VIDEO OUT on the DVD player to the corresponding connector on the TV using the component video cable (not supplied).

Caution: Component video and S-video can not work at the same time, so you have to set one of them to be active by the such way as shown on the chapter [Video output].

Warning!

- Never make or change connections with the power switched on.
- Connect the DVD player directly to your TV, instead of eg. a VCR, to avoid distortion because DVD video discs are copy protected.
- Do not connect the DVD player AUDIO OUT to PHONO IN of your player.



Preparation

Sound

- 1 Digital audio connections provide the clearest sound. Connect one of the DVD player's DIGITAL AUDIO OUT (COAXIAL or OPTICAL) to your amplifier or receiver.
- 2 If digital connections are not possible, connect the DVD player's red and white AUDIO OUT to your amplifier, receiver, stereo or TV.

Connecting to a Audio System

- 1 You can also listen to the sound of audio CDs and DVD video discs by connecting to an optional stereo systems.
- 2 Connect the Left and Right AUDIO OUT on the DVD player to the Left and Right AUDIO IN on the stereo systems.

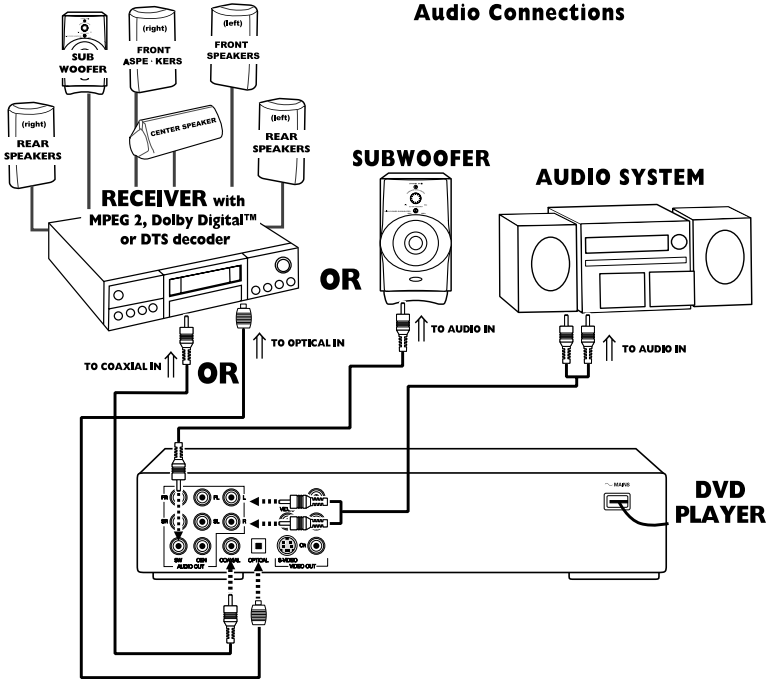

Audio Connections

Connecting to Optional Equipment

- A digital component with a built-in MPEG 2, Dolby Digital™ or DTS decoder allows you to enjoy the surround sound while producing the effect of being in a movie theater or a concert hall.

If your receiver has a Dolby Digital™, MPEG 2 or DTS decoder, Connect to A/V receiver with digital coaxial or optical cable

- Connect the DIGITAL COAXIAL AUDIO OUT of the DVD player to the corresponding input on the receiver using the normal audio or video cable supplied.

Analog connection to a multi-channel A/V receiver with 6 channels audio in connectors

- A multi-channel decoder enables playback of DVDs recorded in multi-channel surround without the need of optional decoder. Connect the audio out jacks to the corresponding jacks of your A/V receiver with six cables. In the SPEAKER SETUP menu, select DOWNMIX to OFF and enable the 6CH decode function by the method introduced on the chapter [Setup Menu].

Notes:

- If the audio format of the digital output does not match the capabilities of your receiver, the receiver will produce a strong, distorted sound or no sound at all.



Preparation

Inserting batteries into the Remote Control

- 1 Open the battery cover.
- 2 Insert batteries with the correct polarity as indicated by the + and - symbols inside the battery compartment.
- 3 Close the cover.

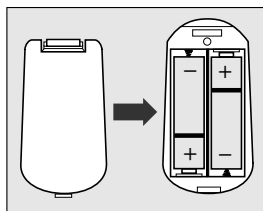

Notes:

- AUTO can only be selected when using a TV that has both the NTSC and PAL systems.
- Slight picture distortions may occur due to this conversion. This is normal. Thus, the AUTO format is most suitable for the best picture quality.

CAUTION!

- Remove batteries if they are exhausted or not to be used for a long time.
- Do not use old and new or different types of batteries in combination.
- Batteries contain chemical substances, so they should be disposed off properly and kept away from children.

Using the Remote Control

- Direct the remote control at the remote sensor of the DVD player.
- Do not drop or give the remote control a shock.
- Do not leave the remote control near extremely hot or humid place.
- Do not spill water or put anything wet on the remote control.

NTSC/PAL Conversion

This player is equipped with a NTSC/PAL conversion feature to convert the video output of the disc to match your TV system. The conversions supported are as below:

| Disc Type | Format | Output format | | |
|-----------|--------|---------------|-----|------|
| | | Selected mode | | |
| | | NTSC | PAL | AUTO |
| DVD | NTSC | NTSC | PAL | NTSC |
| | PAL | NTSC | PAL | PAL |
| VCD | NTSC | NTSC | PAL | NTSC |
| | PAL | NTSC | PAL | PAL |





Preparation

Switching On

- 1 Switch on the TV and DVD player.
- 2 Set the TV to the correct Video IN channel. (eg. EXT1, EXT2, AV1, AV2, AUDIO/VIDEO, etc. Please refer to your TV owner's manual for detail)
→ The player display lights and the default screen appears on the TV.
- 3 If you are using an external equipment (eg. audio system or receiver), turn them on and select the appropriate input source that was used to connect to the DVD player output. Refer to the equipment owner's manual for detail.

Operation

Basic Playback

- 1 Press POWER ON/OFF on the front panel.
- 2 Press OPEN/CLOSE on the front panel to open disc loading tray.
- 3 Place the chosen disc in the tray, with the label facing up.
- 4 Press OPEN/CLOSE again to close the tray.
→ After recognizing this disc the player begin to playback automatically.

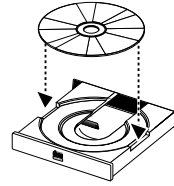

Notes:

- DVDs may have a region code. Your player will not play discs that have a region code different from the region code of your player.
- If 'Disc Lock' is set to ON and the disc inserted is not authorized, the 4-digit code must be entered and/or the disc must be authorized (see 'Disc Lock').

General operation

Video control during playback

STOP DVD VCD CD SVCD

- 1 You can resume the play from the point at which you stopped last time, if you just press the STOP key once. It will start from the beginning if you press the STOP key twice to stop playback.

PAUSE/STEP DVD VCD CD SVCD

- 1 To get a still picture, press PAUSE key during playback.
- 2 To step forward to the next frame picture, press PAUSE key again.
- 3 To resume normal playback, press PLAY.

SEARCH DVD VCD CD SVCD

- 1 To search the contents in fast speed, press the ► or ◀ for fast forward/backward searching.
- 2 Press the ◀ or ► again to increase the speed for searching.
- 3 Press PLAY to return to the normal playback.





Operation

Slow Motion



- 1 To get slow motion effect during playback, press ▲ or ▼.
- 2 Press ▲ or ▼ again, you can get different playback forward/backward speeds.
- 3 Press PLAY to return to the normal play back.



- 1 To get slow motion effect during playback, press ▲.
- 2 Press ▲ again, you can get different playback forward speeds.
- 3 Press the PLAY key to return to the normal play back.

NOTE:

- The SLOW BACKWARD function is not available for the Super VCD/VCD/CD disc.

Audio control during playback



- 1 Press the MUTE key to disable the sound output.
- 2 Press the MUTE key again to remove the mute.

SURROUND SOUND



The DVD player can reproduce virtual surround sound effect.

- 1 Press the Display key on the remote control.
- 2 Press ◀▶ to highlight option 3D
- 3 Press ▲ ▼ to switch it on or off.

NOTE: Before select the surround sound effect, you must set DOWNMIX at the mode of STEREO, LT/RT or VSS(please refer to SPEAKER SETUP PAGE in SETUP MENU).

Audio channel selection



- 1 SVCD has two stereo audio channels which are used for playing karaoke or the audio language selection. (for instance, you can choose one channel for only the music background of the song while you play the karaoke.)
- 2 Press the AUDIO key on the remote control to select the audio channels you want.
- 3 VCD has only one stereo audio channel, you can select mono left audio channel or mono right audio channel by pressing the AUDIO key on the remote control.

Repeat



Repeat chapter/title/disc

- To repeat the current chapter, press REPEAT.
- To repeat the current title, press REPEAT a second time.
- To exit Repeat mode, press REPEAT again.



Repeat track/disc

- To repeat the current track, press REPEAT.
- To repeat the entire disc, press REPEAT a second time.
- To exit Repeat mode, press REPEAT again.



DVD-Video Discs: repeat a sequence in a title

Video and Audio CDs: repeat a sequence in a track

- 1 Press REPEAT A-B at your chosen starting point.
- 2 Press REPEAT A-B again at your chosen end point.
→ The repeat sequence begins.
- 3 To exit the sequence, press REPEAT A-B.

5 Disc Resume



This player can resume the playback of last 5 discs, which should be unload at stop mode.

- 1 Load one disc, which is one of last 5 discs.
- 2 Press PLAY when DVD player is recognizing the disc. if the information of this disc has been stored in the memory of DVD player, it will be played back from the point you stopped last time.





Operation

OSD (On-Screen Display)

DVD **VCD** **SVCD**

This function will provide some information about your playing disc on the screen.

- Press DISPLAY key on the remote control.

Title Selection

- 1 Press ◀▶ to highlight option Title number.
- 2 Press ▲▼ to change the title number.
→ DVD player will playback selected title.

Chapter Selection

- 1 Press ◀▶ to highlight option chapter number.
- 2 Press ▲▼ to change the chapter number.
→ DVD player will playback selected chapter.

Time Search

- Press ◀▶ to highlight time display area.
For DVD discs:
→ CC means the time has been played back of current chapter. CR means the time is remainder of current chapter. TC means the time has been played back of current title. TR means the time is remainder of current title.
For Super VCD or VCD disc
→ DC means the time has been played back of the disc. DR means the time is remainder of the disc. TC means the time has been played back of current track. TR means the time is remainder of current track.
Press ▲ to make the selection.
- Press the ◀▶ keys to highlight the item TIME and you can play from any point of the disc.
→ Enter hours, minutes and seconds from left to right in the time edit box using remote control numerical key pad. (e.g. 0:34:27)
→ Press the OK key to confirm it.

Zoom **DVD** **VCD** **SVCD**

The Zoom function allows you to enlarge the video image.

- 1 Press the ZOOM key to activate the function.
→ Use the ▲▼◀▶ key to view the rest part of the zoomed picture.
→ Playback will continue.
- 2 Press the ZOOM key again to return to the original size.

NOTE: This function is NOT available for PAL DVD discs or some DVD discs.

Special DVD Features **DVD**

Playing a title

A DVD disc may have one or more titles. This depends on the content (a movie, video clips, a drama series, etc) on the disc.

- After you load a disc, information about the content shows on the screen waiting for your selection. Likewise, you can press the TITLE key on the remote control to turn back to the title menu during playback.
→ Press the appropriate numerical key or ▲▼◀▶ keys on the remote control to highlight your selection.
→ Press the OK key to confirm it.

Playing a chapter **DVD**

While you have selected a title, it may include one or more chapters.

- Any time you want to watch another chapter during playback, press DISC MENU key to turn back to the chapter menu (If disc has chapter menu).
→ Press the appropriate numerical key or ▲▼◀▶ keys on the remote control to highlight your selection.
→ Press the OK key to confirm it.
→ After a chapter has been selected, you also can press the ◀◀ or ▶▶ key to make a change.

Camera Angle **DVD**

Some discs contain scenes which have been shot simultaneously from various angles.

This DVD player allows you to select the desired camera angle.

- pressing the ANGLE key on your remote control.
NOTE: The function is available for the DVD discs which have recorded several angles movie.

Changing the audio language **DVD**

- Press AUDIO repeatedly to select the different languages.
NOTE: The function is activated, only if the DVD is recorded with multi-languages audio tracks.

Subtitles **DVD** **SVCD**

- Press SUBTITLE repeatedly to select the different subtitles.
- Press SUBTITLE for about 2 seconds to switch subtitle on or off.
NOTE: The function is activated, only if the DVD or Super VCD is recorded with multi-subtitles.





Operation

Special VCD & SVCD Features

Playback Control (PBC)

PBC function can make you enter the index menu which is used to select a track after loading the SVCD or VCD disc.

If you want to activate the function,

- 1 press the DISC MENU key on the remote control to set the PBC ON.
→ Pay attention to the hint on the screen.
- 2 Use the ◀◀ or ▶▶ key to select the page you like.
→ If the items of the index menus are numbered, press the appropriate numerical key on the remote control.
→ press the OK key to confirm.
- 3 Press the RETURN key to enter the index menu during the play back.

NOTE:

- The content of the index menu depends on the disc. Please refer to the disc's instruction for detail.
- If the disc doesn't include the PBC information, this function will have no effect.

If you want to skip the index menu and playback directly from the beginning,

- 1 press the DISC MENU key on the remote control to switch off the function.
→ For the karaoke discs, even if PBC function is off, you still can use the ◀◀ or ▶▶ key to select the track you like.

5 Disc Resume



This player can resume the playback of last 5 discs, which should be unload at stop mode.

- 1 Load one disc, which is one of last 5 discs.
- 2 Press PLAY when DVD player is recognizing the disc. If the information of this disc has been stored in the memory of DVD player, it will be played back from the point you stopped last time.

Preview function

At STOP mode, press the PREVIEW key to enter previewing menu.



1 Disc introduction

Select this function, DVD player will play back every track several seconds with full screen, that makes you understand the content of disc.

- Press the numerical key 1.
- Press OK key to confirm it.
- Press STOP key to quit previewing.

2 Disc preview

This function will minify the picture of one track enough to display every nine of these tracks on the full screen which will help you to preview a disc.



- Press the numerical key 2.
- Press OK key to confirm it.
- Select the other tracks beyond this page by pressing the ◀◀ or ▶▶ key.
- Press the numerical keys to choose the desired track.
- Press the OK key to confirm it.

3 Track preview

This function is used to divided a single track into nine parts and display them on the full screen which will help you to preview the selected track.



- Press the numerical key 3.
- Press the OK key to confirm it.
- Preview other tracks, press the ◀◀ or ▶▶ key.
- Press numerical key to choose the start point.
- Press the OK key to playback the start point.

4 Quit preview function

- Press the numerical key 4.
- Press the OK key to exit.





Picture CD & MP3 CD Playback

Function introduction

This player can playback JPEG format pictures and MP3 files as well as being specially compatible with Kodak Photo CD.

Picture CD containing JPEG format pictures with file extensions of 'JPG'. The CD can be burned on every computer, and pictures maybe from digital camera or scanner. If the customers prefer, they may make this CD become a Digital Album.

For playing this Digital Album (picture CD) conveniently, our DVD player can

- Auto playback of pictures on disc one at a time.
- Display a preferred picture.
- Zoom the picture.
- Rotate the picture.
- Flip the picture vertically or horizontally.
- Playback speed control.
- Album and track selection.
- Repeat (disc / album / track / picture).
- Nested directory levels supported to 8 levels.
- Maximum album numbers possible is 32.
- Maximum MP3 Tracks Programmable is 96.

Basic playback

- 1 Without any disc inserted and "NO DISC" is shown on set, press the SYSTEM MENU key to open the setup menu.
- 2 Press the ▲ ▼ key to highlight the PREFERENCE item.
- 3 Press OK to open the PREFERENCE menu.
- 4 Press the ▲ ▼ to highlight the SMART NAV menu.
- 5 Press OK to open the menu.
- 6 Press the ► key to enter the menu.
- 7 Press the ▲ ▼ key to highlight the NO MENU or WITH MENU item.
 - NO MENU: playback all images in sequence automatically, and MP3 musics will be played prior to pictures.
 - WITH MENU: playback images in the selected folder.
- 8 Press the OK key to confirm your selection.

Special functions during playback:

Auto playback

After you open one picture, the player can playback each file in sequence automatically.

Selection playback

- 1 Press the numerical key to select your favourite file directly.
- 2 In the JPEG playback menu, press the ◀ ▶ ▲ ▼ key to select the folder you want and press the OK to open it.
- 3 Press the ◀ ▶ ▲ ▼ key to highlight your favourite file and press the OK key to confirm.

Preview function

- 1 Press the PREVIEW key at the STOP mode. You will see nine pieces of minified pictures on the screen.
- 2 Press the ►► or ◀◀ key to display the next or the previous nine-picture-preview.
- 3 Press the ◀ ▶ ▲ ▼ key to highlight one of them and press the OK to display.

Playback with multi-angles

When displaying one picture on TV screen

- Press the ▲ ▼ ◀ key to get different effects.
 - ▲ key: Flip the picture vertically.
 - ▼ key: Flip the picture horizontally.
 - ◀ key: rotate the picture anti-clockwise.

Playback Speed Control

- Press the ► key to adjust the playback speed.

Zoom picture

- Press the ZOOM key to display the picture with different scales.
- Press the ◀ ▶ ▲ ▼ key to view the rest of the zoomed picture.

Note:

If you want to switch between MP3 musics and pictures during automatical playback, please press a valid number as shown on the TV screen after the DVD player indexed the MP3 musics and pictures found in the loaded disc.





KARAOKE

General operation of karaoke function

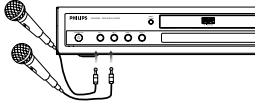

- 1 Connect microphone to MIC1 or MIC2 or to both sockets. Be sure the player has been properly connected to your TV or audio system.
- 2 Press KARAOKE on the remote control to display karaoke menu.
→ karaoke menu appears on TV screen, and the option 'MIC' is highlighted.
● Press ▲ ▼ to switch on karaoke function.
- 3 Load a karaoke disc and press PLAY to playback.
- 4 Turn on the microphone which is connected with the DVD player and you can enjoy the Karaoke immediatly.

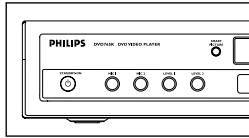

- To adjust the volume of microphone, turn the knob LEVEL1 or LEVEL2 on the right of front panel.
- 5 Press KARAOKE on the remote control to display karaoke menu.
→ karaoke menu appears on TV screen, and the option 'MIC' is highlighted.
● Press ▲ ▼ to switch off karaoke function.

NOTE: Please set the option DOWNMIX to LT/RT, VSS or STEREO before switching on Karaoke function.

General setup of karaoke function

Press MODE to display karaoke menu (Karaoke menu will disappear if you do not press any key in a minute).

KEY CONTROL

- 1 Press ◀ ▶ to highlight the option KEY.
- 2 Press ▲ ▼ to adjust the pitch to adopt your voice.

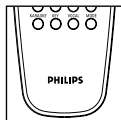

Volume

- 1 Press ◀ ▶ to highlight the option VOLUME.
- 2 Press ▲ ▼ to adjust the VOLUME to adopt your voice.

ECHO

- 1 Press ◀ ▶ to highlight the option ECHO.
- 2 Press ▲ ▼ to adjust the echo level.

Audio channels option

With this function, you can choose audio channels during karaoke is available.

- 1 Press VOCAL on the remote control to choose STEREO, LEFT VOCAL, RIGHT VOCAL, MONO RIGHT or MONO LEFT .
→ MONO RIGHT & MONO LEFT options can fade out the original vocal.

Karaoke learning and language learning function

- 1 Press MODE to display karaoke menu.
→ Make sure you have set MIC on.
- 2 Press ◀ ▶ to highlight RECORD OFF.
- 3 Press ▲ to set RECORD on.
- 4 Press ▲ again to start recording from the point you prefer.
→ DVD player will record your voice and original karaoke music.
- 5 Press ▲ again to end recording.
→ DVD player will playback the recording three times in total to let you make a comparasion.
- 6 Follow the instruction of step4 to step5 to record other sequence.
- 7 As soon as you finish recording, press ▼ to quit Karaoke learning and language learning function.



Setup Menu

Basic operations

- 1 Press SYSTEM MENU in the STOP mode to enter the Setup Menu.
- 2 Press the OK key to open the next level submenu or confirm your selection.
- 3 Press the ◀▶ keys to enter the submenu or return to the previous menu.
- 4 Press the ▲▼ keys to highlight the desired menu.
- 5 Press SYSTEM MENU to quit the setup menu.
→ When you quit the setup menu, the settings will be stored in the player's memory even if the player is switched to power off.

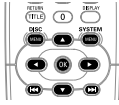

General setup menu

Some settings are needed in this menu. they are: DISC LOCK, PROGRAM, OSD LANGUAGE and SCREEN SAVER.

Follow the steps below:

- 1 Press the SYSTEM MENU key to enter the setup menu.
- 2 Press the ▲▼ keys to choose the GENERAL SETUP menu.
- 3 Press the OK key to confirm selection.

Disc lock

When the disc is locked, the player will store its typical code into the memory for the future identification. For the next playback, the DVD player will prompt to enter the password.

- 1 Press the ▲▼ keys to highlight the DISC LOCK item in the GENERAL SETUP menu.
- 2 Press the OK key.
- 3 Enter its submenu by pressing the ▶ key.
 - LOCK: Lock the disc being played.
 - UNLOCK: unlock the disc.
- 4 Press the ◀ key to return to the GENERAL SETUP menu.

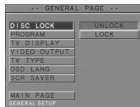

NOTE:

1. When playback a locked disc, the DVD player will prompt to enter your password or 3308 (default) password.
2. To change the password, refer to the option PASSWORD in the PREFERENCES menu.

Program (not available for DVD discs)

- 1 To choose the PROGRAM item, press the ▲▼ keys.
- 2 Press OK to open its submenu.
- 3 Press the ▶ key to move the cursor to the field of the submenu to choose the item ON.
→ ON: Enter the PROGRAM

- 4 Press OK to enter the program page.

Input your favorite track

- 1 Input valid track number by pressing the numerical keys.
- 2 Press the ◀▶▲▼ keys to move the cursor to the next selected position.
- 3 Repeat the steps above to input another track number until the whole program is completed.

Exclude a track

- 1 Press the ◀▶▲▼ keys to move the cursor to track you want to exclude.
- 2 Input an invalid track number to cancel this track.



Cancel all tracks

- 1 Press the ◀▶▲▼ keys to move the cursor to the CLEAR button.
- 2 Press OK, all tracks will be cancelled.
- 3 Now you can input your favorite tracks again.

Playback tracks

When programming is completed,

- 1 Press the ◀▶▲▼ keys to move the cursor to the PROG button.
- 2 Press OK.
→ DVD player will playback the selected program under the programmed sequence.

Stop the program playback

At the PROGRAM page, When programming is completed,

- 1 Press the ◀▶▲▼ keys to move the cursor to the QUIT button.
- 2 Press the OK key to quit this menu.

VFD Dim

This function is used to adjust the brightness of VFD on the front panel.

- 1 Press the ▲▼ keys to highlight VFD DIM in the GENERAL SETUP menu.
- 2 Press OK.
- 3 Enter its submenu by pressing the ▶ key.



Setup Menu

- 4 Move the cursor by pressing the ▲▼ keys to highlight the selected item.
 - 100: make the VFD brighter than normal.
 - 70: standard brightness
 - 40: make the VFD dimness.
- 5 Press OK to confirm.
- 6 Press the ◀ key to return to the GENERAL SETUP menu.

OSD language

There are two options available for information display on TV screen.

- 1 Press the ▲▼ keys to highlight OSD LANG in the GENERAL SETUP menu.
- 2 Press the OK key.
- 3 Enter its submenu by pressing the ▶ key.
- 4 Move the cursor by pressing the ▲▼ keys to highlight the selected item.
 - ENGLISH: OSD information will be displayed in English.
 - CHINESE: OSD information will be displayed in Chinese.
- 5 Press the OK key to confirm.
- 6 Press the ◀ key to return to the GENERAL SETUP menu.



Screen saver

This function is used to turn on or off the screen saver.

- 1 Press the ▲▼ keys to highlight SCR SAVER in the GENERAL SETUP menu.
- 2 Press OK.
- 3 Enter its submenu by pressing the ▶ key.
- 4 Move the cursor by pressing the ▲▼ keys to highlight the selected item.
 - ON: At STOP mode, if nothing is happened within 5~6 minutes, screen saver will turn on .
 - OFF: Screen saver is disable.
- 5 Press OK to confirm.
- 6 Press the ◀ key to return to the GENERAL SETUP menu.



Speaker setup page

This menu contains setup options of your speaker system, such as DOWNMIX, D.R.C.(Dynamic Range Compression), CENTER, REAR, SUBWOOFER, CENTER DELAY, REAR DELAY ,TEST TONE and BASS

REDIR, which gives the setup system to reproduce high quality surround sound.

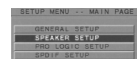

- 1 Press SYSTEM MENU.
- 2 Press the ▲▼ keys to highlight the SPEAKER SETUP item.
- 3 Press OK to confirm.

DOWNMIX mode

- 1 Press the ▲▼ keys to highlight the DOWNMIX item.
- 2 Press OK to open its submenu.
- 3 Enter its submenu by pressing the ▶ key.
- 4 Move the cursor by pressing the ▲▼ keys to highlight the selected item.
 - LT/RT
 - This item will be used only if your DVD player is connected with Doby Prologic decoder. Meanwhile, the DVD player can send the output of Doby Prologic signals.
 - STEREO
 - This item will help to downmix the signal of Doby Digital and DTS into stereo signals directly outputing from L/R port.
 - VSS
 - This function is to make DVD player reproduce virtual surround sound effects.
 - OFF
 - Disable the DOWNMIX mode so that you can setup your speaker system.
- 5 Press OK.
- 6 Press the ◀ key and return to the SPEAKER SETUP menu.



D.R.C. (Dynamic Range Compression)

DVD player will compress dynamic range of sound effect output, when you do not want to disturb your neighbours and your family in midnight.

- 1 Press the ▲▼ keys to highlight D.R.C.,
- 2 Press OK to open its submenu.
- 3 Enter its submenu by pressing the ▶ key.
- 4 Move the cursor by pressing the ▲▼ keys to highlight the selected item.
 - ON: Enable D.R.C.
 - OFF: Disable D.R.C.
- 5 Press OK.
- 6 Press the ◀ key to return to the SPEAKER SETUP menu.





Setup Menu

Center speaker

This function is effective only when DOWNMIX is OFF. When you are using a center speaker, set to CENTER on in the menu.

- 1 Press the ▲▼ keys to highlight the CENTER item.
- 2 Press OK to open its submenu.
- 3 Enter its submenu by pressing the ► key.
- 4 Move the cursor by pressing the ▲▼ keys to highlight the selected item.
 - ON: Enable signal output for center speaker.
 - OFF: Disable signal output for center speaker.
- 5 Press OK.
- 6 Press the ◀ key and return to the SPEAKER SETUP menu.



- 4 Move the cursor by pressing the ▲▼ keys to highlight the selected item.
 - ON: Enable signal output for subwoofer speaker.
 - OFF: Disable signal output for subwoofer speaker.
- 5 Press OK.
- 6 Press the ◀ key to return to the SPEAKER SETUP menu.

Center delay

Set CENTER to on in the setup to delay the sound reproduction from the center speaker.

- 1 Press the ▲▼ keys to highlight the CNTR DELAY item.
- 2 Press OK to open its submenu.
- 3 Enter its submenu by pressing the ► key.
- 4 Move the cursor by pressing the ▲▼ keys to highlight the selected item.
- 5 Press OK.
- 6 Press the ◀ key and return to the SPEAKER SETUP menu.



Surround speaker

This function is effective only when DOWNMIX is OFF. When you are using rear surround speaker, set to REAR on in the menu.

- 1 Press the ▲▼ keys to highlight the REAR item.
- 2 Press OK to open its submenu.
- 3 Enter its submenu by pressing the ► key.
- 4 Move the cursor by pressing the ▲▼ keys to highlight the selected item.
 - ON: Enable signal output for surround speaker.
 - OFF: Disable signal output for surround speaker.
- 5 Press OK.
- 6 Press the ◀ key to return to the SPEAKER SETUP menu.



Surround delay

Set REAR on then you can setup this option to delay the sound reproduction from the surround speakers.

- 1 Press the ▲▼ keys to highlight the REAR DELAY item.
- 2 Press OK to open its submenu.
- 3 Enter its submenu by pressing the ► key.
- 4 Move the cursor by pressing the ▲▼ keys to highlight the requisite item.
- 5 Press OK.
- 6 Press the ◀ key and return to the SPEAKER SETUP menu.



Subwoofer speaker

This function is effective only when DOWNMIX is OFF. When you are using a subwoofer speaker, set to SUBWOOFER on in the menu.

- 1 Press the ▲▼ keys to highlight the SUBWOOFER item.
- 2 Press OK to open its submenu.
- 3 Enter its submenu by pressing the ► key.

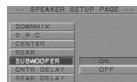

Bass Redirection

This option can reproduce bass effect from front speakers and center speaker by transferring bass signals to them instead of subwoofer.

- 1 Press the ▲▼ keys to highlight the item BASS REDIR.
- 2 Press OK to open its submenu.
- 3 Enter its submenu by pressing ►.
- 4 Pressing ▲▼ to highlight the requisite item.
 - ON: enable bass signal redirection.
 - OFF: disable bass signal redirection.
- 5 Press OK.





Setup Menu

Test tone

This item is used to check the connection of the audio system. When TEST TONE is ON, a fizzy sound from every speakers will appear.

- 1 Press the ▲▼ keys to highlight the TEST TONE item.
- 2 Press OK to open its submenu.
- 3 Enter its submenu by pressing the ► key.
- 4 Move the cursor by pressing the ▲▼ keys to highlight the selected item.
 - ON: Enable test tone.
 - OFF: Disable test tone.
- 5 Press OK.
- 6 Press the ◀ key and return to the SPEAKER SETUP menu.



Pro Logic setup

This item is used for settings on Dolby Pro Logic signals.

- 1 Press SYSTEM MENU to enter the SETUP menu.
- 2 Press the ▲▼ keys to choose the PRO LOGIC SETUP menu.
- 3 Press OK to enter.
- 4 Press the ▲▼ keys to highlight the PRO LOGIC item.
- 5 Press OK to open its submenu.
- 6 Enter its submenu by pressing the ► key.
- 7 Move the cursor by pressing the ▲▼ keys to highlight the selected item.
 - ON: Output the Dolby Pro Logic signals.
 - OFF: Forbid the Dolby Pro Logic signals to send output.
 - AUTO: Whether PRO LOGIC is ON or OFF, it depends on the audio format of the disc you playback.
- 8 Press OK.
- 9 Press the ◀ key and return to the SPEAKER SETUP menu.
- 10 Press the ▲▼ keys to highlight the MAIN PAGE and confirm by pressing OK.

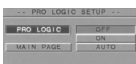

SPDIF setup

In this menu, you can set up digital audio format outputing from coaxial and optical terminals.

- 1 Press SYSTEM MENU to enter the SETUP menu.
- 2 Press the ▲▼ keys to choose the SPDIF SETUP menu.
- 3 Press OK.

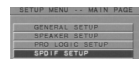

NOTE:

SPDIF is the abbreviation of Sony Philips Digital Interface which is a protocol of digital data transferring.

SPDIF OUT setup

- 1 Press the ▲▼ keys to highlight the SPDIF OUT item.
- 2 Press OK to open its submenu.
- 3 Enter its submenu by pressing the ► key.
- 4 Press the ▲▼ keys to highlight the selected item.
 - RAW: Original digital signals output.
 - PCM: Convert to PCM signals to output.
- 5 Press OK.
- 6 Press the ◀ key and return to the SPDIF SETUP menu.



LPCM 96K mode

In this menu, you can set up sampling rate to decode LPCM audio.

- 1 Press the ▲▼ keys to highlight the LPCM 96K item.
- 2 Press OK to open its submenu.
- 3 Enter its submenu by pressing the ► key.
- 4 Move the cursor by pressing the ▲▼ keys to highlight the selected item.
 - ON: Detect the loading disc for appropriate sampling rate.
 - OFF: The decoding process is under the sampling rate of 48KHz.
- 5 Press OK.
- 6 Press the ◀ key to return to the SPDIF SETUP menu.

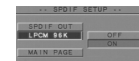



Setup Menu

Video Out Setup

There are items included in VIDEO OUT PAGE menu as TV DISPLAY, VIDEO OUTPUT, TVTYPE VIDEO MODE, BRIGHTNESS, CONTRAST, SATURATION.

- 1 Press STOP twice.
- 2 Press SYSTEM MENU to enter its menu.
- 3 Highlight the VIDEO OUTPUT SETUP item by pressing the ▲▼ keys.
- 4 Press OK.

Video output

In this menu, you can select the video output for high quality picture.

- 1 Press the ▲▼ keys to highlight VIDEO OUTPUT in the VIDEO OUTPUT SETUP menu.
- 2 Press the OK key to open its submenu.
- 3 Press the ► key to highlight the item of the submenu.
- 4 Press the ▲▼ keys to choose an item.
 - S-VIDEO: Video signals will send an output from the S-VIDEO on the rear panel of the DVD player.
 - YCBCR: If your TV set is equipped with Y/CB/CR input, you can choose for high quality picture.
- 5 Press OK.
- 6 Press the ◀ key to return to the VIDEO OUTPUT SETUP menu.

NOTE: Any selection will not influence the signal output of composite video.

TV display

Select the aspect ratio of the TV to be connected.

16:9 → when you connect a wide-screen TV to the DVD player.

4:3 LETTER BOX → when you connect a normal TV to the DVD player. Displays a wide picture with bands displayed on the upper and lower portions of the TV screen.

4:3 PAN SCAN → when you connect a normal TV to the DVD player. Displays the wide picture on the whole TV screen with a portion automatically cut off.

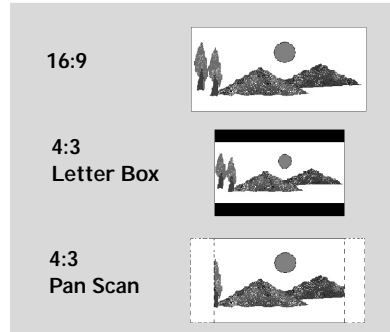

Setup the item as follows,

- 1 Press the ▲▼ keys to highlight the TV DISPLAY item in the GENERAL SETUP menu.
- 2 Press the OK key.
- 3 Enter its submenu by pressing the ► key.
 
- 4 Move the cursor by pressing the ▲▼ keys to highlight the selected item.
- 5 Press OK.
- 6 Press the ◀ key to return to the VIDEO OUTPUT SETUP menu.

TV type

Before viewing the DVD or VCD, ensure that the PAL or NTSC setting of the system matches your TV set.

- 1 Press the ▲▼ keys to highlight TVTYPE in the GENERAL SETUP menu.
 
- 2 Press OK.
- 3 Enter its submenu by pressing the ► key.
- 4 Move the cursor by pressing the ▲▼ keys to highlight the requisite item.
- 5 Press OK.
- 6 Press the ◀ key to return to the VIDEO OUTPUT SETUP menu.

NOTE: Choosing NTSC item indicates that the player will output by NTSC system. Similarly, you can acquire PAL system by choosing the PAL item. And the item MULTI means video output is depending on the format of DVD or VCD discs.





Setup Menu

Smart Picture function

In this menu, you can personalize your picture setting, colors (brightness, contrast, saturation and hue) can be changed to a fixed set of ideal predefined picture setting (Bright, Standard and Soft) or personal one, to suit various viewing situation.

Video Mode

In this menu, you can choose one picture setting from a fixed set of ideal predefined picture setting (Bright, Standard and Soft).

- 1 Press the ▲▼ keys to highlight VIDEO MODE in the VIDEO OUT SETUP menu.
- 2 Press OK to open its submenu.
- 3 Press the ► key to highlight the item of the submenu.
- 4 Press the ▲▼ keys to choose an item.
 - BRIGHT: make the TV screen brighter.
 - STANDARD: select a standard picture setting.
 - SOFT: make the TV screen softer.
 - PERSONAL: apply the setting you set before.
- 5 Press OK.
- 6 Press the ◀ key to return to the VIDEO OUTPUT SETUP menu.

Personal Picture Setting

Personal picture setting includes the setup of BLACK LEVEL, BRIGHTNESS, CONTRAST, SATURATION and HUE, with which you can personalize your picture setting.

Brightness

- 1 Press the ▲▼ keys to highlight BRIGHTNESS in the VIDEO OUT SETUP menu.
- 2 Press OK to open its submenu.
- 3 Press the ► key to highlight the item of the submenu.
- 4 Press the ▲▼ keys to adjust the brightness level.
- 5 Press OK.
- 6 Press the ◀ key to return to the VIDEO OUTPUT SETUP menu.

Contrast

- 1 Press the ▲▼ keys to highlight CONTRAST in the VIDEO OUT SETUP menu.
- 2 Press OK to open its submenu.
- 3 Press the ► key to highlight the item of the submenu.
- 4 Press the ▲▼ keys to adjust the contrast level.
- 5 Press OK.
- 6 Press the ◀ key to return to the VIDEO OUTPUT SETUP menu.

Saturation

- 1 Press the ▲▼ keys to highlight SATURATION in the VIDEO OUT SETUP menu.
- 2 Press OK to open its submenu.
- 3 Press the ► key to highlight the item of the submenu.
- 4 Press the ▲▼ keys to adjust the saturation level.
- 5 Press OK.
- 6 Press the ◀ key to return to the VIDEO OUTPUT SETUP menu.





Setup Menu

Preferences setup

There are items included in PREFERENCES menu as AUDIO, SUBTITLE, DISC MENU, PARENTAL CONTROL, PASSWORD, DEFAULT and SMART NAV.

- 1 Press the STOP key twice.
- 2 Press SYSTEM MENU to enter its menu.
- 3 Highlight the PREFERENCES item by pressing the ▲▼ keys.
- 4 Press OK to confirm your selection.



Audio language

DVD discs are available for multiple audio languages. Use this item to choose your preferred default audio language.

- 1 Press the ▲▼ keys to highlight the AUDIO item.
- 2 Press OK to open its submenu.
- 3 Enter its submenu by pressing the ► key.
- 4 Move the cursor by pressing the ▲▼ keys to highlight the selected item.
- 5 Press OK.
- 6 Press the ◀ key to return to the PREFERENCES menu.



NOTE: Your DVD disc may not include the audio language which you set in the SETUP menu. If so, the player will use other audio language instead.

Subtitle language

DVD discs are available for multi-subtitle language. This item is used to choose default subtitle language.

- 1 Press the ▲▼ keys to highlight the SUBTITLE item.
- 2 Press OK to open its submenu.
- 3 Enter its submenu by pressing the ► key.
- 4 Move the cursor by pressing the ▲▼ keys to highlight the selected item.
- 5 Press OK.
- 6 Press the ◀ key to return to the PREFERENCES menu.



NOTE: Your DVD disc may not include the subtitle which you set in the SETUP menu. If so, the player will use other audio language and subtitle instead.

Disc menu language

DVD discs are available for multiple disc menu languages. This item is used to choose default disc menu language.

- 1 Press the ▲▼ keys to highlight the DISC MENU item.
- 2 Press OK to open its submenu.
- 3 Enter its submenu by pressing the ► key.
- 4 Move the cursor by pressing the ▲▼ keys to highlight the selected item.
- 5 Press OK.
- 6 Press the ◀ key to return to the PREFERENCES menu.



NOTE: If your DVD disc doesn't include disc menu language you have set, the player will use other recorded language instead.

Password

This password is used for the parental control and disc lock. Enter your password when you are required by the DVD player.

- 1 Press the ▲▼ keys to highlight the PASSWORD item.
 - 2 Press OK to open its submenu.
 - 3 Enter its submenu by pressing the ► key.
 - 4 Move the cursor by pressing the ▲▼ keys to highlight the selected item.
 - 5 Enter the current 4 digit code.
 - 6 If successful, the player will prompt for a new one.
 - 7 After that, enter the new password again to reconfirm.
 - 8 Press the PLAY key to return to the PREFERENCES menu.
- The new 4 digit code will take effect.

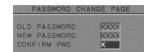

NOTE:

1. You can change the setup of parental control and disc lock with a recognised password being entered.
2. If you forget the password, you can enter the default password 3308 and replace your password after logging on.





Setup Menu

Parental Control

Movies on DVDs may contain scenes not suitable for children. Therefore, discs may contain 'Parental Control' information which applies to the complete disc or to certain scenes on the disc. These scenes are rated from 1 to 8, and alternative, more suitable scenes are available on the disc. Ratings are country dependent. The 'Parental Control' feature allows you to prevent discs from being played by your children or to have certain discs played with alternative scenes.

- VCD, SVCD, CD has no level definition, so parental control function has no effect on those kinds of discs as well as most of illegal DVD discs.
- You can follow the steps below to setup the parental control:

- 1 Press the ▲▼ keys to highlight the PARENTAL item.
- 2 Press OK to open its menu.
- 3 Move to its submenu by pressing the ► key.
- 4 Then use the ▲▼ keys to highlight a rating from 1 to 8 for the disc inserted.
- 5 Press OK to confirm, then press the ◀ key to return to the PREFERENCES menu.



No Parental Control

Parental Control is not activated. The Disc will be played in full.

- 1 Select NO PARENTAL item.
- 2 Press OK.

Ratings 1 to 8:

The disc contains scenes not suitable for children. If you set a rating for the player, all scenes with the same rating or lower will be played. Higher rated scenes will not be played unless an alternative which has the same rating or lower is available on the disc. If no suitable alternative is found, playback will stop and the 4-digit code has to be entered.

Default setup (shown on the left)

If some problems occur during setting DVD, the item DEFAULT is used to reset all items to factory default and all your personal setting will be erased.

- 1 Press the ▲▼ keys to highlight the DEFAULT item.
- 2 Press OK to open its menu.
- 3 Enter its menu by pressing the ► key.
- 4 Press OK.



NOTE: When this function is executed, all setups will be reset to factory defaults.

Smart Navigator

In this menu, it contains of the setting when you playback picture CD and MP3 CD.

- 2 Press the ▲ ▼ key to highlight the PREFERENCE item.
- 3 Press OK to open the PREFERENCE menu.
- 4 Press the ▲ ▼ to highlight the SMART NAV menu.
- 5 Press OK to open the menu.
- 6 Press ► to enter the menu.
- 7 Press ▲ ▼ to highlight the NO MENU or WITH MENU item.
 - NO MENU: playback all images or MP3 musics in sequence automatically
 - WITH MENU: playback images or MP3 musics in the selected folder.
- 8 Press the OK key to confirm your selection



Specifications

PLAYBACK SYSTEM

DVD Video
Video CD & SVCD
CD (CD-Recordable and CD-Rewritable)
PICTURE CD
MP3-CD
CD-R, CD-RW
DVD+RW

VIDEO PERFORMANCE

* CVBS 1Vpp --- 75Ω
* S-VIDEO Y: 1.00Vpp --- 75Ω
C: 0.30Vpp --- 75Ω
* Component video Output Y: 1.00Vpp --- 75Ω
CR: 0.7Vpp --- 75Ω
CB: 0.7Vpp --- 75Ω

AUDIO FORMAT

| | | |
|---------|------------------------|---|
| Digital | Mpeg/ AC-3/ DTS PCM | compressed Digital 16, 20, 24 bits fs, 44.1, 48, 96 kHz 24, 32, 56, 64, 96, 128, 256 kbps & variable bit rate fs, 16, 22.05, 24, 32, 44.1, 48 kHz |
| | MP3(ISO 9660) | |

Analog Sound Stereo
Full decoding of Dolby Digital and DTS multichannel surround sound

AUDIO PERFORMANCE

| | |
|---------------------|--|
| DA Converter | 24bit |
| Signal-Noise (1kHz) | 100dB |
| Dynamic range(1kHz) | >80dB |
| DVD | fs 96 kHz 4Hz- 22kHz fs 48 kHz 4Hz- 22kHz |
| SVCD | fs 48 kHz 4Hz- 22 kHz fs 44.1kHz 4Hz- 20kHz |
| CD/VCD | fs 44.1kHz 4Hz- 22kHz |

TV STANDARD (PAL/50Hz) (NTSC/60Hz)

| | | |
|-----------------|---------------|------------|
| Number of lines | 625 | 525 |
| Playback | Multistandard | (PAL/NTSC) |

CONNECTIONS

| | |
|------------------------|---|
| Component Video Output | Cinch |
| S-Video Output | Mini DIN 4-pins |
| Video Output | Cinch |
| Audio Output(5.1) | Cinch |
| Audio Output(L+R) | Cinch |
| Digital Output | 1 coaxial / optical IEC958 for CD/DA / LPCM/ MPEG1 IEC1937 for MPEG 2, Dolby Digital and DTS |

CABINET

| | |
|------------------------|----------------------|
| Dimensions (w x d x h) | 435 x 286 x 75 mm |
| Weight | Approximately 3.0 Kg |

Specifications subject to change without prior notice

Maintenance

Cleaning the Cabinet

- Use a soft cloth slightly moistened with a mild detergent solution. Do not use a solution containing alcohol, spirits, ammonia or abrasives.

Cleaning Discs

- When a disc becomes dirty, clean it with a cleaning cloth. Wipe the disc from the center out. Do not wipe in a circular motion.
- Do not use solvents such as benzene, thinner, commercially available cleaners, or antistatic spray intended for analog records.

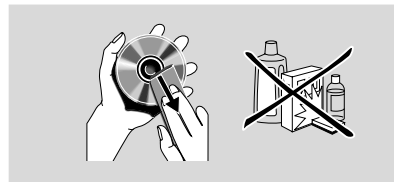



Troubleshooting

WARNING

Under no circumstances should you try to repair the system yourself, as this will invalidate the warranty. Do not open the system as there is a risk of electric shock.

If a fault occurs, first check the points listed below before taking the system for repair. If you are unable to remedy a problem by following these hints, consult your dealer or service center.

| Problem | Solution |
|--|---|
| No power | <ul style="list-style-type: none"> – Check if the AC power cord is properly connected. |
| No picture | <ul style="list-style-type: none"> – Check if the TV is switched on. – Check the video connection. |
| Distorted picture | <ul style="list-style-type: none"> – The disc is badly scratched or dirty. – Sometimes a small amount of picture distortion may appear. This is not a malfunction. |
| Completely distorted picture or black/white picture with DVD or Video CD | <ul style="list-style-type: none"> – Make sure the NTSC/PAL setting at the DVD player matches the video signal of your television. (See NTSC/PAL Conversion) |
| No sound or distorted sound | <ul style="list-style-type: none"> – Adjust the volume. – Check that the speakers are connected correctly. |
| No audio at digital output | <ul style="list-style-type: none"> – Check the digital connections. – Check the settings menu to make sure the digital output is set to ALL or PCM. – Check if the audio format of the selected audio language matches your receiver capabilities. |
| Disc can't be played | <ul style="list-style-type: none"> – Ensure the disc label is facing up. – Check if the disc is defective by trying another disc. |
| No return to start-up screen when disc is removed | <ul style="list-style-type: none"> – Reset the unit by switching the player off, then on again. |
| The player does not respond to the remote control | <ul style="list-style-type: none"> – Aim the remote control directly at the sensor on the front of the player. – Reduce the distance to the player. – Replace the batteries in the remote control. – Insert the batteries with their polarities (+/- signs) as indicated. |
| Buttons do not work | <ul style="list-style-type: none"> – In order to completely reset the player, unplug the AC cord from the AC outlet. |
| Player does not respond to some operating commands during playback. | <ul style="list-style-type: none"> – Operations may not be permitted by the disc. Refer to the instructions of the disc. |
| DVD Video player cannot read CDs/DVDs | <ul style="list-style-type: none"> – Use a commonly available cleaning CD/DVD to clean the lens before sending the DVD Video player for repair. |





Meet Philips at the Internet
<http://www.philips.com>

DVD736K



3141 015 21841



The products and services described herein
are not necessarily available in all countries
Due to continuous product improvements this
document is subject to change without notice.